

Revision 1.E Release Date July 11 2007
Revision Notes - updated format, block diagram

This document applies to part numbers 1092 and 4032.

Technical Specifications Summary

Frequency Range: 170 - 230 MHz
P1dB: 400 Watts CW
Class: AB
Supply Voltage: 28.0V

Gain: 16 dB
Efficiency: 45%
Temperature Range: 0 to +70°C
Max VSWR: 5:1

Amplifier General Description

The **P400-VHF-H-16** is an integrated TV linear amplifier designed for the television integrator. Providing a minimum of 350W Pk linear power, the P400-VHF-H-16 is the perfect amplifier for any high band VHF transmitter. Featuring quadrature input and output combining, this unit is isolated from most external circuit problems. This amplifier uses Gold metallized MOSFETs.

- No RF assembly or circuit tuning!
- 400 Watts of Linear Output Power!
- Combined **Video and Aural** at full rated power!
- 16dB typical gain at Channel 13!
- Modular Construction for ease of Integration!
- Operating unit at 32.0V DC will result in an approximate 10% improvement in linear power and P1dB

Amplifier Picture



Delta RF Technology, Inc.
High Power RF Amplifiers and Accessories
350 South Rock Boulevard • Reno • NV • 89502 • USA

Phone +1.775 DELTA RF [775 335 8273]
Fax +1.775 DELTA FX [775 335 8239]
website: <http://www.drft.com>
email: sales@drft.com

| Parameter | Min | Typ | Max | Units | Notes |
|---------------------------------|-----|-------|-------|------------|--------------------------------------|
| Frequency | 170 | | 230 | MHz | |
| P1dB | 55 | 56 | | W, CW | +56dBm minimum at 32V DC operation |
| Linear Power Out | 350 | | | W, Pk Sync | |
| IMD3 | -40 | | | dBc | For 2 tones, 1MHz spacing, 350 W PEP |
| Power Input | | 6 | 11 | W, CW | |
| Gain | 15 | 16 | | dB | |
| Vsupply | | 28 | | V, DC | |
| Drain Current | | 17 | | A, DC | |
| Input VSWR | | 1.2:1 | 1.5:1 | | |
| Insertion Phase Variation | | ±5 | | ° | Unit to unit |
| Gain Variation | | ±1 | | dB | Unit to unit |
| F2 Second Harmonic | | -40 | | dBc | |
| F3 Third Harmonic | | -23 | | dBc | |
| Baseplate Operating Temperature | 0 | | +70 | °C | |

Physical Dimensions 6.5" x 4.0" x 1.5" / 17cm x 10cm x 4cm

All specifications valid for 50 Ω output load, $V_{sup} = +28VDC$, $I_{dq} = 1.6A$

Absolute Maximum Ratings

| Parameter | Value | Units | Notes |
|----------------------------------|----------------|-------|-------|
| Maximum Operating Voltage | +34.0 | VDC | |
| Stable Operating Voltage | +26.0 to +32.0 | VDC | |
| Maximum Bias Current | 3.0 | A, DC | |
| Maximum Drain Current | 24 | A, DC | |
| Load Mismatch Survival | 5:1 | | |
| Storage Temperature | -40 to +105 | °C | |
| Maximum Operating Baseplate Temp | +70 | °C | |

Features, Auxillary Functions

Features Include:

- Temperature Compensated Bias
- Temperature Controller- Analog Temp Output
- High Temp alarm with automatic PA disable
- High Temp alarm output
- Amplifier Disable
- Current Sense, Each Transistor
- Connectorized Power and I/O
- Amplifier is capable of 350W CW. Please inquire about copper baseplate version for operation to 400W CW.



Pout vs. IMD3
2-Tone Input f1=215MHz, f2=216MHz

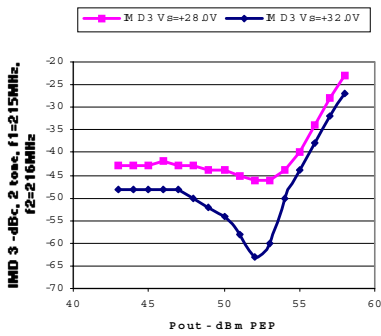

IMD vs. NTSC-NA Channel
Pout = 400W Pk Sync

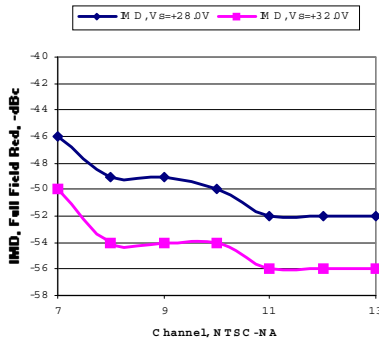

IMD vs. Pout
Channel 13, NTSC-NA

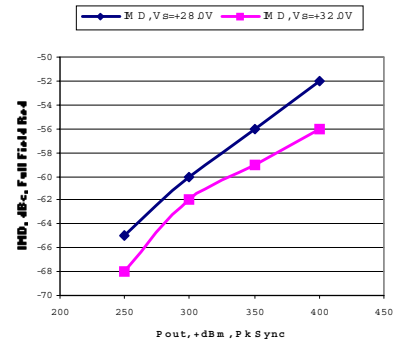

Compression point of P400-VHF-H @ 225MHz

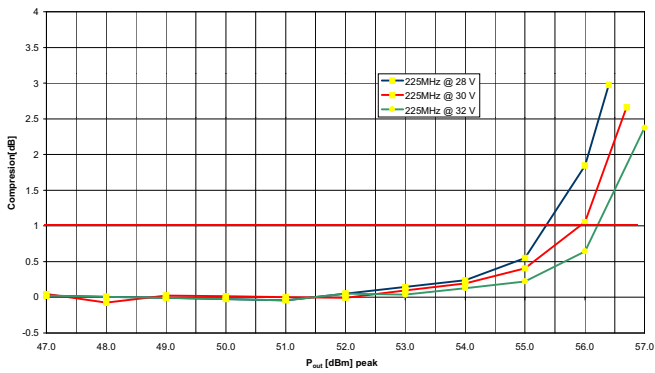

Power Gain of P400-VHF-H @ 200MHz

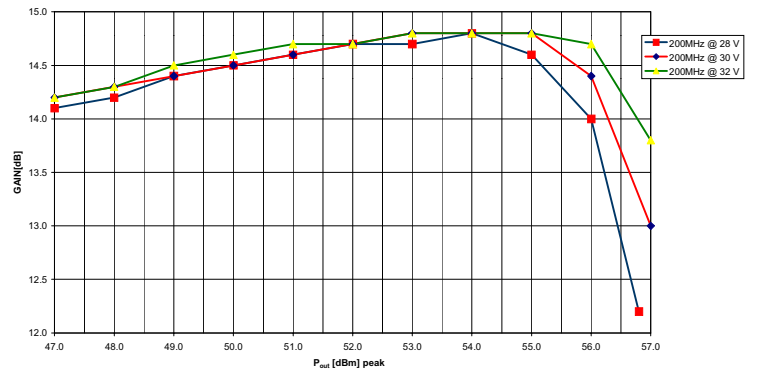

Pout vs Pin P400-VHF-H @ 200MHz

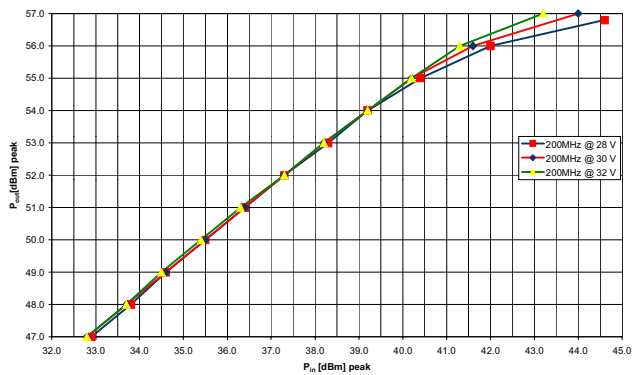

Efficiency of P400-VHF-H @ 225MHz

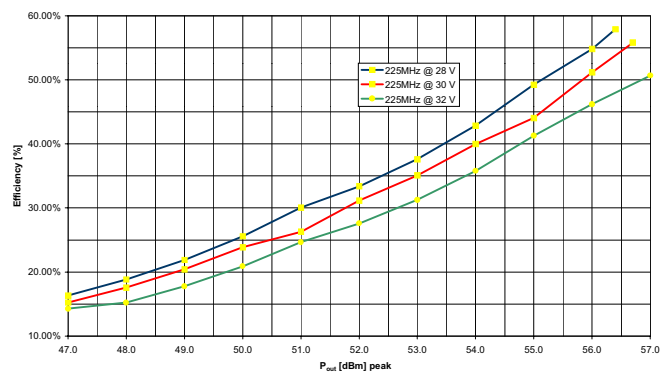

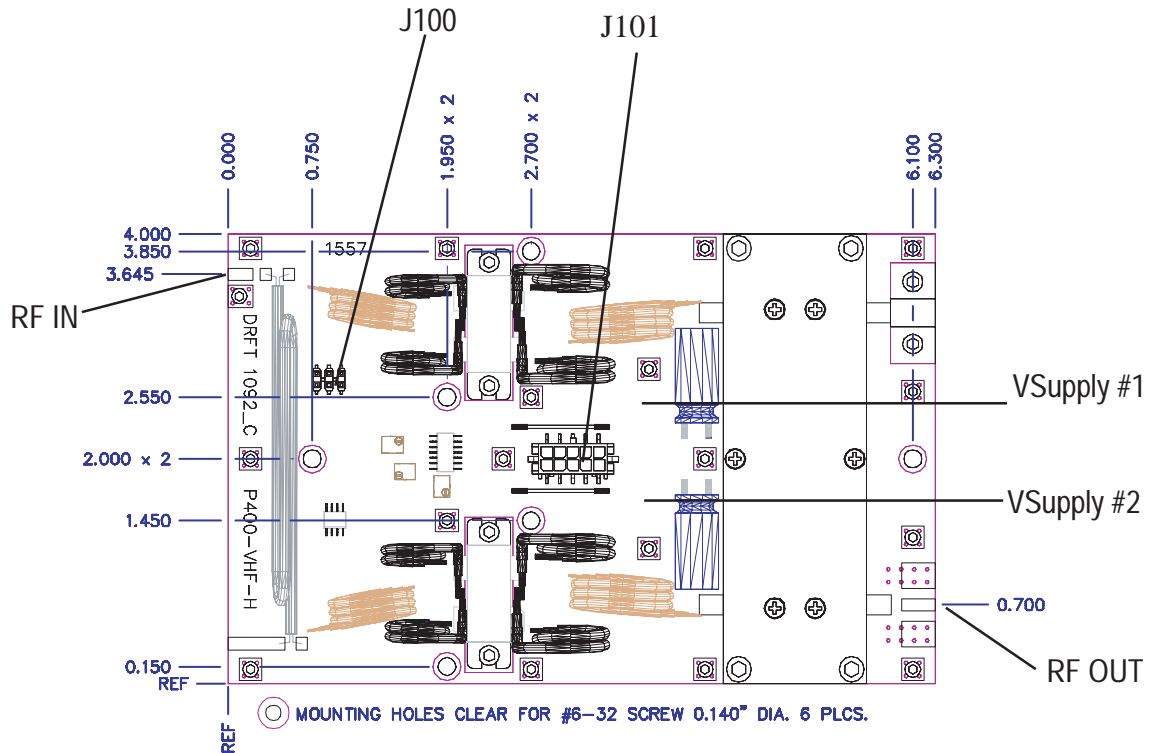

Tips for Mechanical Mounting:

- 1 All holes are clear for #6 Screw. Stainless Steel mounting hardware is recommended, grade 18-8 or better. A lock washer of same material should also be used.
- 2 Ensure mounting surface is flat to better than 0.003" / "
- 3 Use a thin layer of thermal compound on the backside of the PA - no more than 0.001" - 0.002" thickness!
- 4 Torque all screws to 10-12 in-lbs

Considerations for Mechanical Mounting:

- Considerations for proper thermal design include
- Total power dissipated = Total DC Power Consumed x (1-Efficiency)
- Ambient Airflow
- Thermal Resistance of Heat Sink

For this PA, typical DC efficiency is 40%. At 400W Pk power output, 200W Average, +32.0V DC operation, 544 total watts are consumed, which leaves 344W dissipated power. If we assume an input air temperature of +25°C, and a maximum desired baseplate temperature of 55°C, this leaves a temperature differential between baseplate and ambient air of 30°C. The desired thermal resistance for heatsink mounting surface to air is therefore 30°C/344W = 0.09°C/W.

Since the baseplate is aluminum, it is important to find a heat sink that it sized at the same outline as the PA which can give this thermal resistance. For example, a 230mm x 127mm heat sink with serrated fins, 70mm in length, (40 fins across 127mm dimension) with an air velocity of 4 m / s achieves this value.

Both VSupply #1 and #2 must be powered



Electrical Connections:

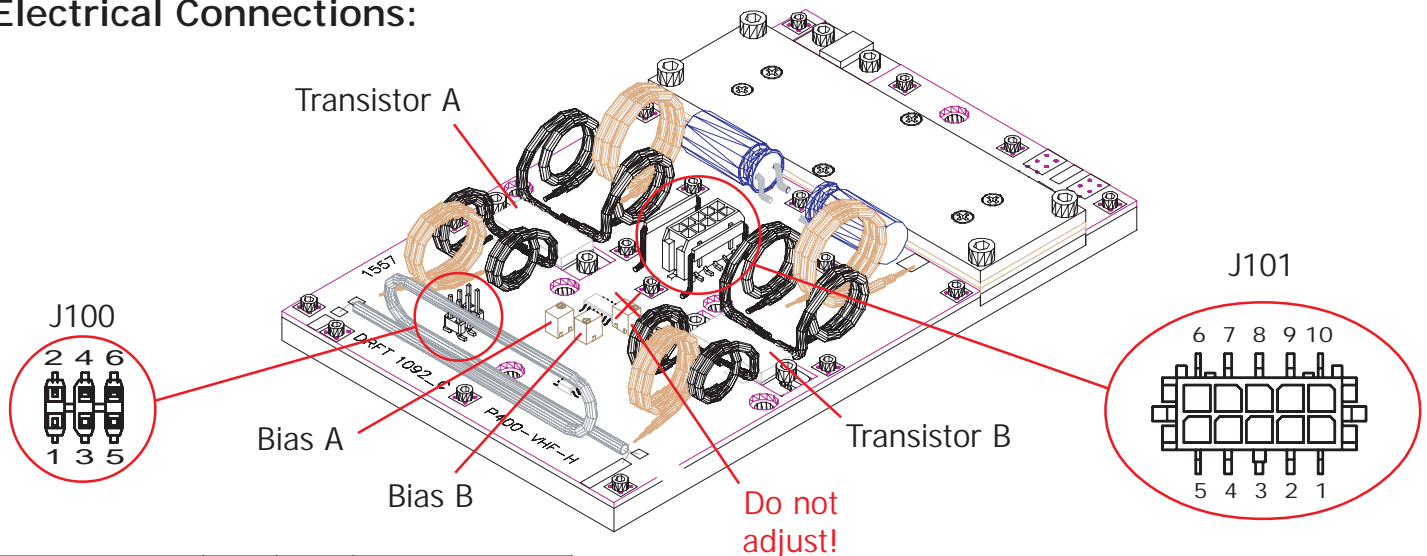

| | J100-1 | ALARM_OUT | TTL Hi when baseplate exceeds 70C |
|---|--|-----------|--|
| I/O Standard 0.100" pitch DIP /DC header: SAMTEC type IDS, HCSD 3M type 89106-0101 AMP 102393-1, 102398-1 BERG 71602-306 -or- Solder directly to Pin in I/O connector | J100-2 | ALARM_IN | Jumper to J100-1 for automatic shutdown at 70C, automatically re-enables at 60C |
| | J100-3 | GROUND | |
| | J100-4 | BIAS_SUP | Power to the Bias and Control circuitry <i>Power must be applied for PA operation</i> |
| | J100-5 | TEMP | Baseplate Temperature |
| | J100-6 | DISABLE | TTL Hi to Disable amplifier |
| | Power 3.0mm Micro Connector: MOLEX 43025-1000 MOLEX Pin 43030-0001, 43030-0007 AMP 1-794617-0 AMP Pin 794610, 794606 -or- Solder directly to pad adjacent to connector | J101-1 | CURRENT_B |
| J101-2,3,8,9 | | GROUND | System Ground |
| J101-4,5,6,7 | | Vsup | +28 to +32 VDC |
| J101-10 | | CURRENT_A | Current Sense, Transistor A |

Connections:

Connect amplifier to +Vsup and Ground using either 3.0mm modular 10-position plug (J101) or soldering directly to pads adjacent to connector. If using Single connection, 14 gauge wire to each side is recommended, 12 gauge ground wire. 20 gauge wire is recommended for use in modular connector, and all power connections must be used! In all cases, use of teflon insulated wire is highly recommended.

I/O connector (J100) must have +Vsup (+24V minimum) DC applied to J100-4 to supply power to bias and control circuitry. All other connections are optional.

Connect coaxial cable to input and output RF connections (semi rigid or flexible) using best RF practices. Ensure output cable is of sufficient power handling rating. Pads are provided for ground on co-axial connections.

Amplifier Startup

+Vsup should be applied to amplifier with no drive and with no bias applied. The system must allow drain voltage to reach +26V minimum before applying bias and drive or damage will result to the amplifier and void warranty. This typically takes between 2 - 10 seconds and should be verified by the system integrator. This can be accomplished in several ways:
 1) Apply power to amp at J101, and remove power from J100-4. After proper voltage has been reached, apply voltage to J100-4 as described above. Amplifier is ready for use.
 2) Apply power to amp at J101, and J100-4. Place a TTL Hi (+5V) to J100-6 DISABLE. After proper voltage has been reached, remove TTL Hi from J100-6 DISABLE. Amplifier is ready for use.

Bias Current:

Bias current is controlled via temperature compensated bias system that uses a hermetically sealed glass thermistor as reference. If excessive air is directed above the amplifier such that the thermistor is cooled below the temperature of the baseplate, this circuitry may not perform properly. Bias has been pre-set at the factory to 0.8A each side at +28.0V DC. This bias point has been selected to offer the optimum balance between IMD performance, efficiency, and gain. If the bias point is changed, take great care to set the same bias point on each transistor, and not to exceed the bias listed on page 1.

Fault Condition - Bad VSWR

Current sense J101-1, J101-10 should be monitored for excessive current. The voltage difference between J100-10 (transistor A) to J100-4,5,6,7 and J100-1 (transistor B) to J100-4,5,6,7 is scaled 1A per 0.010 V. If either transistor experiences currents in excess of normal operation, a fault condition exists, and the amplifier should be disabled through J100-6 DISABLE. If current on either transistor drops to below 0.5A indicated, a fault condition exists, and the amplifier should be disabled through J100-6 DISABLE.

Temperature Sense and Temperature Fault

An on board temperature controller reports temperature on pin J100-5 TEMP. This is scaled to +395mV + (Temperature °C X +6.20mV/°C) and has an output impedance of 1.5kohm typical. An output alarm, J100-1 ALARM OUT, is TTL Low when the temperature exceeds approximately 70°C, and the alarm is cleared when the baseplate temperature drops below approximately 60°C. For automatic operation, jumper J100-1 ALARM OUT to J100-2 ALARM IN and the amplifier will automatically disable by removing bias when the temperature exceeds 70°C, and automatically re-enable when the temperature drops below 60°C.

Amplifier Shutdown

To prevent damage to amplifier and surrounding systems, bias and drive should be removed prior to powering down PA. This can be accomplished by removing voltage from J100-4, or by applying TTL Hi (+5V) to J100-6 DISABLE. Power can safely be removed from PA.

Miscellaneous:

It is normal for the output quadrature and the output transformers (flexible coax on the output of transistors A and B) to get warm during operation. These components are rated for continuous operation in excess of 150°C. Placing noisy analog or digital systems, such as additional control circuitry, directly over the top of transistors or RF path can cause improper operation. Care should be taken to locate these components where they will not cause interference.



Block Diagram

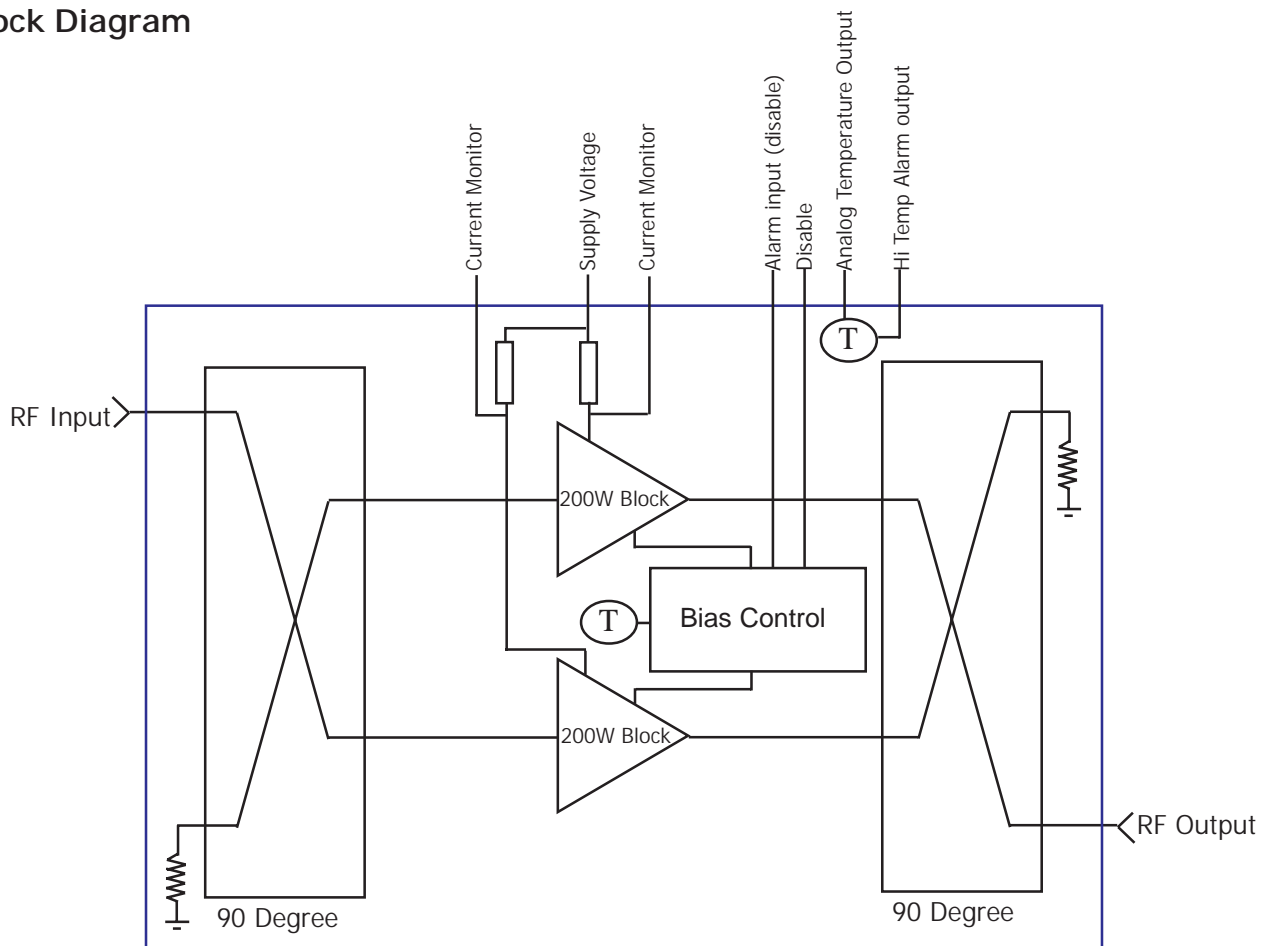

Theory of Operation

RF Input signals are presented at 'RF Input' within parameters as specified by the data sheet. RF Input signal is routed into the input quadrature where it is evenly split. Half of the signal is routed into one transistor, the second half is phase shifted by 90 degrees and fed into the second transistor. The transistors amplify the two signals where they are fed into the output quadrature. The first signal which was not phase shifted is now shifted 90 degrees to be coherent with the second signal. The combined power is presented at RF Output. Any mismatch is dumped into the output quadrature resistor.

The Bias control circuitry monitors supply voltage and keeps transistors disabled until supply voltage has reached a safe voltage. This is accomplished by grounding the gates of the transistors. A voltage is induced across a thermistor which has an opposite temperature coefficient to the transistors. This keeps the quiescent current steady over the operating range assuring linear operation. A disable line accomplishes the same result using a TTL input.

A separate temperature controller outputs a low level DC voltage scaled to the baseplate temperature. When the baseplate temperature exceeds 70C, the temperature alarm output goes high. This line can be tied to an auxiliary disable line to keep the pallet safe from extended temperatures.



Ordering Information:

| Order Code | Description | DRFT Reference |
|-----------------|---|----------------|
| P400-VHF-H-16 | 400W VHF Band III TV L inear Pallet Amplifier | 1092 |
| PAB400-VHF-H-16 | Amplifier in Enclosure | 4032 |

Options

| | | |
|------|--|------|
| -A11 | SMA Female Connectors In / Out | 0201 |
| -A12 | Heat Sink Option | 0202 |
| -A13 | Heat Sink Option with DC Fan, pre wired | 0203 |
| -A14 | Ruggedized for vibration | 0204 |
| -A15 | Wire harness, 1' length, 10 wires for pallet amplifier only (NON-FM) | 0205 |
| -A16 | Wire harness, customer specified length for pallet amplifier only | 0206 |
| -T2 | Extended Burn In | 0271 |
| -T3 | Extended Data Collection | 0272 |

Standard Pallet Options:

SMA Female Connectors, Input and Output. Stainless Body, Gold Center pin, 4-hole SMA bolted to pallet amplifier edge through bottom two holes located at amplifiers RF IN and RF OUT locations. All stainless steel hardware.

Enclosure- all aluminum machined enclosure available for most pallet amplifiers. Alodined aluminum, alloy 6061-T6. SMA Female input and output RF connectors. Supply voltage and ground through solder / feedthrough connections. Module must be bolted to appropriate heatsink.

Heat Sink - aluminum extruded heat sink, black anodized. Pallet amplifier or module will be bolted to heatsink. Customer will be required to provide adequate airflow.

Heat sink with fan - aluminum extruded heat sink as above, with included fan bolted to push air through the heat sink. Depending on heat requirements, a second fan may also be provided on the output of the unit.

Ruggedized - all screws have threadlocking compound applied, and all flying components are staked and attached to base. Designed to withstand MIL-STD-810E 514.4 Category 8.

Power Connector - a 10 pin molex connector is used on all standard pallet amplifiers to supply +Vsup and Ground connections, as well as hi-side current shunts for current monitoring. Delta RF offers the mating connector with 1' wires - Red (Vsup), Black (Ground), Yellow (Current monitor). All wires are 18 gauge teflon insulated wires. Customer may optionally specify wire length and wire color.

Testing Options:

Standard - includes power test and brief burn - in under laboratory conditions. Printed test report gives graph of Gain and Input Return Loss at rated P1dB and Voltage Conditions. Report shows pass/fail criteria. All amplifiers include this test.

Extended burn in - 8-hour burn in at P1dB with standard test run at completion. Unit is monitored during test and any discrepancy reported. Standard test data is included.

Extended data collection - Standard data is run and included. Detailed data is taken point by point giving the customer 25 - 70 frequency points, depending on the amplifier model. For each frequency point, data is generated to include gain, input power, input return loss, current, second harmonic, third harmonic, efficiency, audio distortion.

Other tests available - Vibration, Temp cycling, Shock. Please inquire.

The specifications contained herein are subject to change without notice. Delta RF Technology, Inc. assumes no liability for the use of this information.

This data sheet and contents are the property of Delta RF Technology, Inc. © Delta RF Technology, Inc. 2007.

